

## TC.8 8 mm CAPILLARY PIPE

# imatge ASD

MODELS:

TC.8 ABS White

SIZE:

Quotes in Millimeters

D =  $\varnothing$  32,5  
d =  $\varnothing$  25  
d-2 =  $\varnothing$  8  
Z = 20  
Z-2 = 22  
L = 65

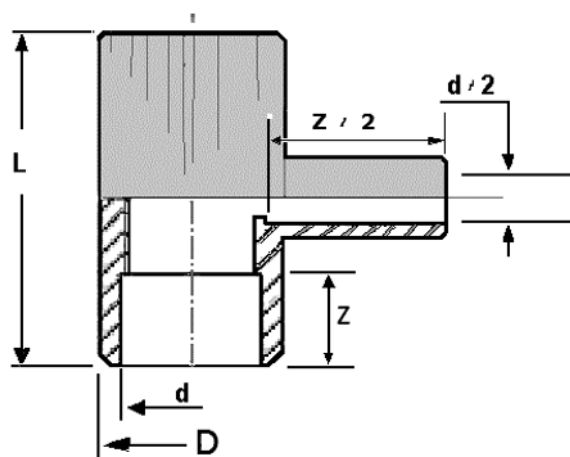

Presentation: **5 units bag.**

MATERIAL:

ABS (Acrylonitrile-Butadiene-Styrene)

Robust polymere with physic features for optimum strength to expansion and impact, hard resistance, high longevity, high resisting to temperatures bellow 0°.

ABS is a Halogen-free thermoplastic.

Maximum temperatures of use. -35° to 60°

PIPE	SECTION	ASD SYSTEMS
	DATE	MARCH 2015
8 mm CAPILLARY	REVISED	J. VALLS
	REF.	<b>TC.8</b>